

**TACTILE IMPRESSION FEATURE
BEST PRACTICE GUIDE**

Best Practices Guide

Introduction

The Tactile Impression Feature is an entry level security feature used to increase the tamper resistance of a card as well as highlight and promote the customer brand in our Datacard® Inline Lamination Module and Tactile Impression Module. This unique feature can be combined with laminates and overlays to provide the right level of security for your card program, and is available on the following systems:

- Entrust SD460 Card Printer
- Entrust CD800 Card Printer with Inline Lamination Module
- Entrust CR805 Retransfer Card Printer with Inline Card Lamination Module
- Entrust CR805 Retransfer Card Printer with Tactile Impression Module
- Entrust Sigma DS3 Card Printer with Tactile Impression Module

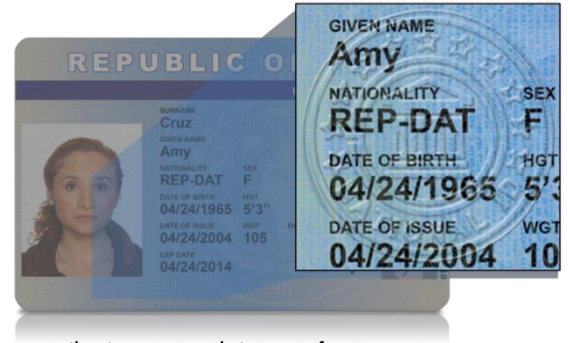

New

The “Color” Tactile Impression Feature is a new security feature that is also used to increase the tamper resistance of a card as well as highlight and promote the customer brand. This unique feature can be available on the following systems:

- Entrust Sigma S3 with Tactile Impression Module
- Entrust CR805 with Tactile Impression Module

There are several options for you to consider when purchasing the tactile impression feature. Generic designs, representing multiple market segments, have been created and are currently available for ordering. Additionally, you have an option to create a unique, custom design specific for your ID card program. The tactile impressions can contain text, logos, and outlines of images that may vary in design and complexity.



This guide will outline the requirements for creating a custom design and help you determine how the tactile impression and new color tactile impression feature can enhance the security of your card program and promote your brand. Review this guide completely as all of the design elements impact your card design in different ways.

Best Practices Guide

Card Layout Recommendations

Inline Card Lamination Module (CLM)

There are several things to consider when determining where to place the tactile impression on your card. Ideally, you want to have the impression cover part of a variable photo or text to maximize the tamper evidence of personalized data on the card.

Refer to this image for the following notes

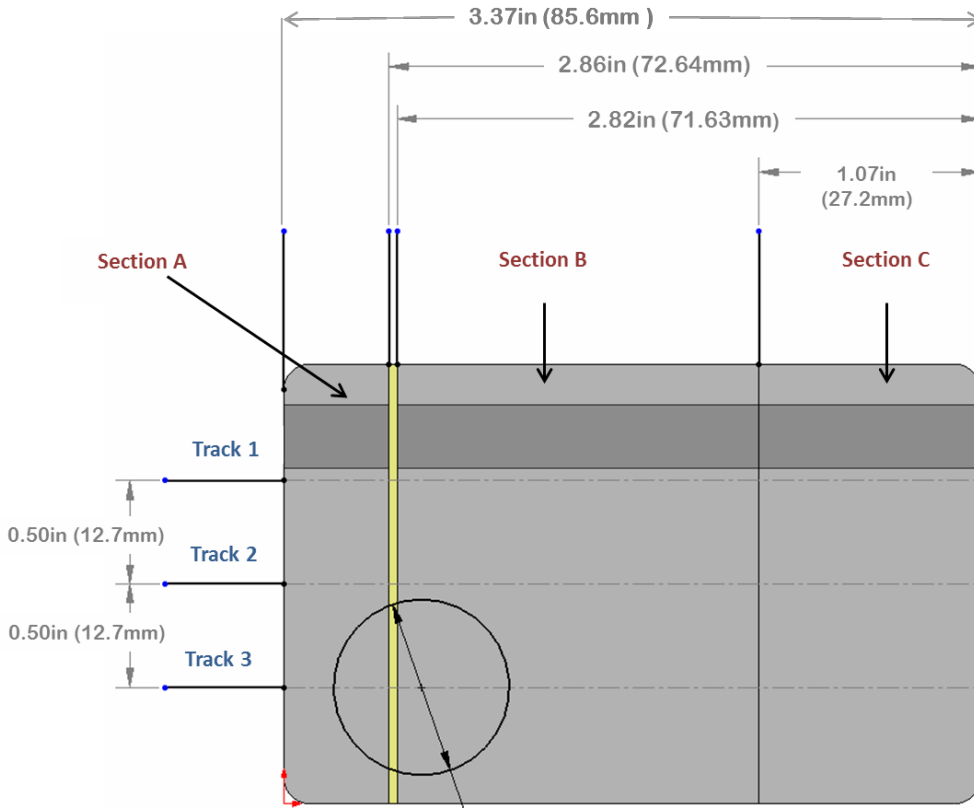

Best Practices Guide

Track 1, 2 and 3

- There are 3 tracks defined in the design of the card: Track 1, 2 and 3.
- Think of the tracks as guidelines for the center of the design.
- The tactile impression can be moved along any of those three tracks.
- The design can be impressed up to 3 times along the tracks.

Sections of the Cards

- There are three sections noted on the card image: Section A, B and C.
- The center of any impression made on the card has to be in Section B, to the right of yellow line noted in the card image.
- The image may overlap into Section A or C, as noted in the image above.

Tactile Impression Module

Refer to this image for the following notes

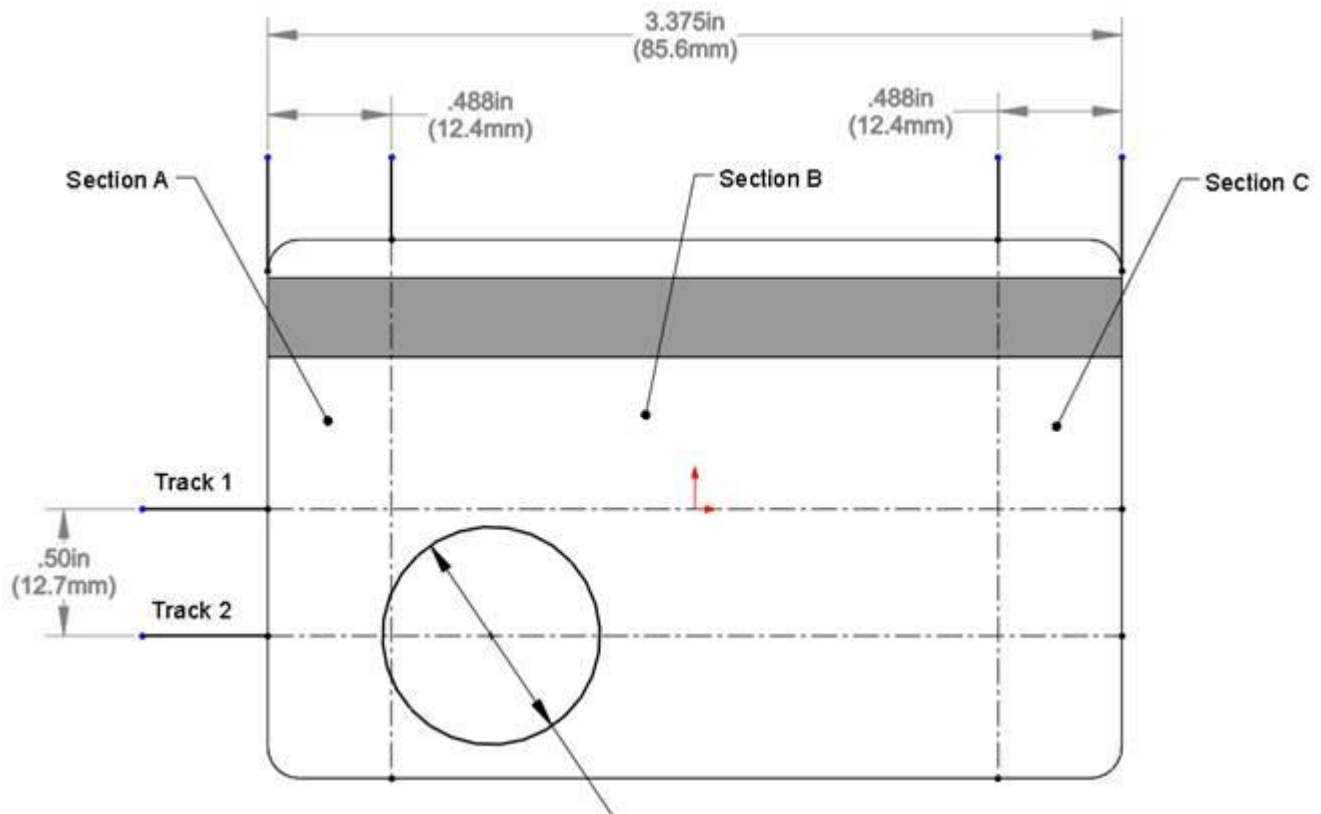

Track 1 and 2

- There are 2 tracks defined in the design of the card: Track 1 and 2. NOTE: Track 1 and 2 on TIM are the same vertical positions of track 2 and 3 on CLM
- Think of the tracks as guidelines for the center of the design.
- The tactile impression can be moved along any of those two tracks.
- The design can be impressed 1 time along the tracks.

Sections of the Cards

- There are three sections noted on the card image: Section A, B, and C
- The center of any impression made on the card has to be in Section B, to the right of yellow line noted in the card image.
- The image may overlap into Section A or C, as noted in the image above

Best Practices Guide

Common Card Layout Recommendations

The following recommendations are common between both the Tactile Impression Module as well as the Inline Lamination module.

- The impression may move slightly on each card as it passes through. The variability differs by section
 - o Section A: +/- 0.010in (.25mm)
 - o Section B: +/- 0.040in (1mm)
 - o Section C: +/- 0.080in (2mm)
- This may become important if the card being impressed has an antenna. Account for this potential variance when determining the location of the impression and the location of the antenna.

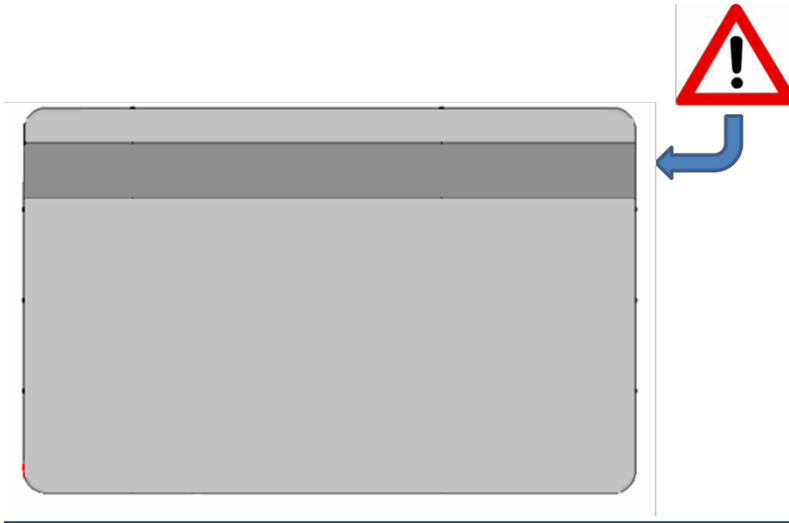

It is not recommended that you impress over the magnetic stripe as this may damage it.

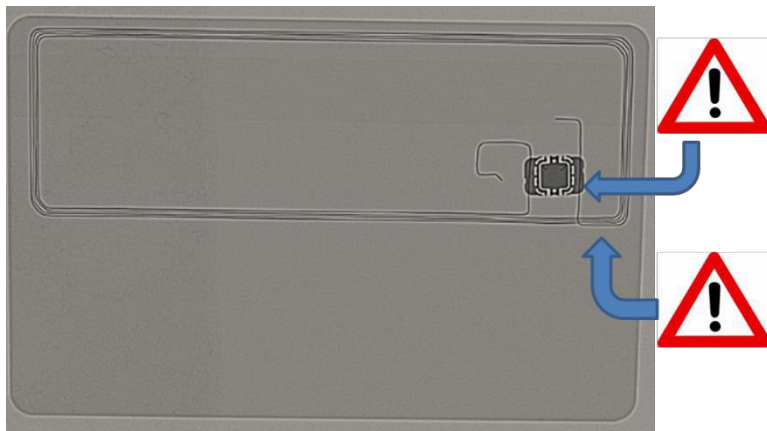

It is also highly recommended that you do not impress over contactless chips or antenna or contact chips. The .5 in sized die is ideal for cards with a contactless chip, in order to avoid impressing over the antenna.

IMPORTANT NOTE: There is variability in the location of the antenna or smart chips in every card. We recommend you check with the manufacturer of the card for exact location and variance.

In addition, we also recommend you do not impress over OCR text or bar codes.

Best Practices Guide

Card Layout Examples

Below are X-ray image examples of commonly used smart cards. These are for reference only and should not be used to decide placement of the tactile impression for your card program. We recommend you check with the manufacturer of the card for exact location and variance.

GemPlus (Gemalto) card for Mifare/Type A



Oberthur card for 14443 Type B

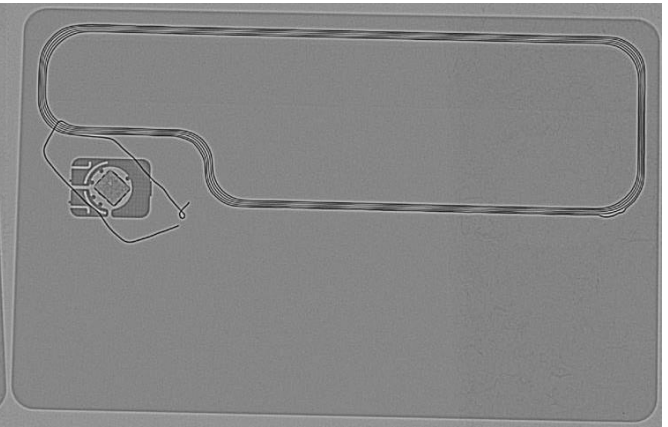

GemPlus (Gemalto) card for ISO14443 Type B

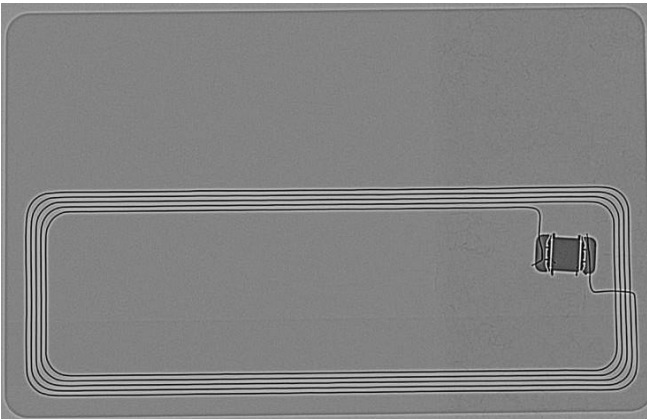

CPI card for ISO14443 Type B

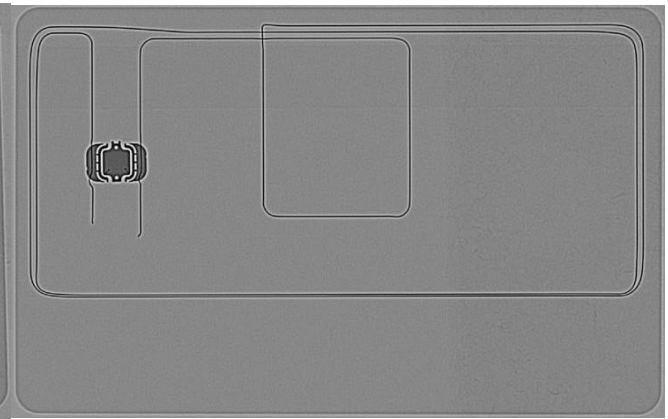

G & D card for ISO14443 Type A

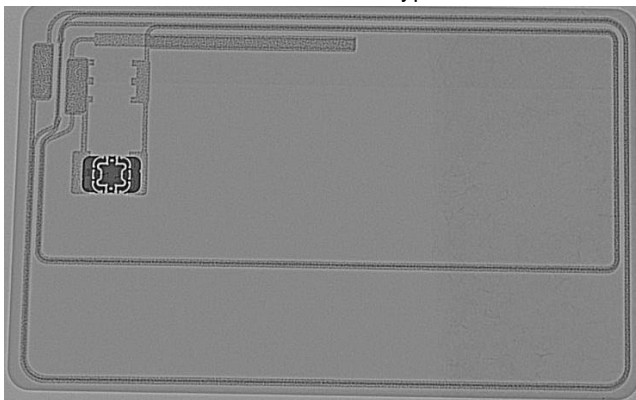

Best Practices Guide

Recommended Card Types

It is recommended that the tactile impression feature is used with card technology compatible with the appropriate print technology. Please refer to the system datasheet for acceptable card types. The depth of the impression can be adjusted to impress on different types of cards. Refer to the installation manual for directions on setting or changing the dwell depth for your card.

Recommended Durability and Security Solutions for Inline Card Lamination Module (CLM)

There are a wide variety of laminates and overlays that can be used with the tactile impression feature. Clear overlays and laminates provide the durability required to protect and extend card life for a range of card use applications. To enhance security, the tactile impression feature can be paired with any of our Datacard® DuraShield™ Overlays or DuraGard® Laminates featuring Datacard® Opti Series Security Features. From basic offerings that provide lower minimum order requirements, to complex designs for programs requiring the utmost security, we can deliver solutions you need to help ensure a successful ID card program. Note: The depth may need to be adjusted based on the type of material used. Refer to the installation manual for directions on setting or changing the dwell depth for your card.

Design Orientation

When designing a custom tactile impression, consider the orientation of the design, and whether or not you will be printing multiple card types with both portrait and landscape orientations. Once the die is inserted in the tactile impresser module, it can't be rotated based on card orientation.

If you select a die that has to be oriented one way or the other, and you use both portrait and landscape orientations, the design may not be desirable.



In the following cards, the tactile impression design is designed for a card with a landscape design, and when printed on a vertically oriented card, the impression does not rotate.

Best Practices Guide

With a more symmetrical design, the tactile impression can fit both landscape and portrait orientations.

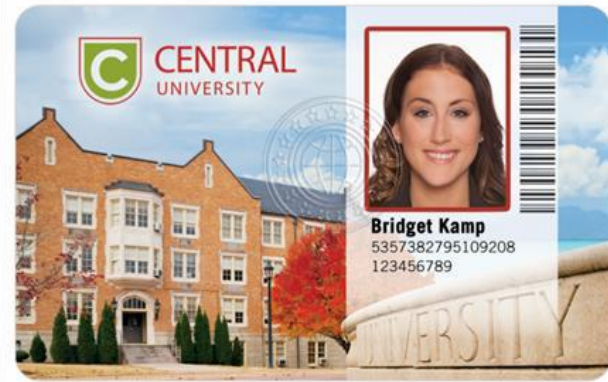

Tactile Impression Diameter

There are two options to choose from when selecting the size of your tactile impression. The size you select will determine the amount of detail you will be able to design into the impression.

The diameter of the impression should also be considered when designing your card. A smaller impression may work better if you want to repeat the design multiple times, or if there are areas of the card that need to be avoided such as a contactless antenna.

Tactile Impression Shape

The design of the impression can be any size or orientation, as long as it fits in the diameter of the impression size selected.

Examples of potential designs.

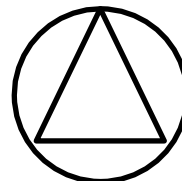
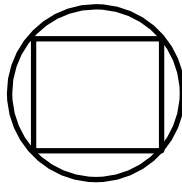
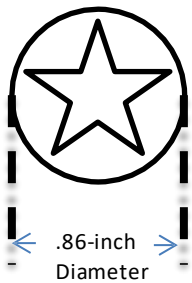

Tactile Impression Design

The tactile impression feature can be a design, text or a combination of both. This gives you an opportunity to use the impression to highlight and promote your brand or make the card more easily identifiable and unique to your program.

Best Practices Guide

Image Requirements

The following guidelines provide more detail on the design of a custom tactile impression feature. These guidelines and recommendations will ensure you get the best impression for your card program. The tactile impression module has different requirements than the inline card lamination modules.

Inline Card Lamination Module (CLM)

There is limited ability to reproduce fine lines, so that should be considered in your design. The minimum line thickness is .003 in (0.076mm), and .006 in (0.153mm) spacing is required between all features.

- *Minimum Line Thickness:* .003" (0.076mm)
- *Minimum Spacing:* .006" (0.153mm)

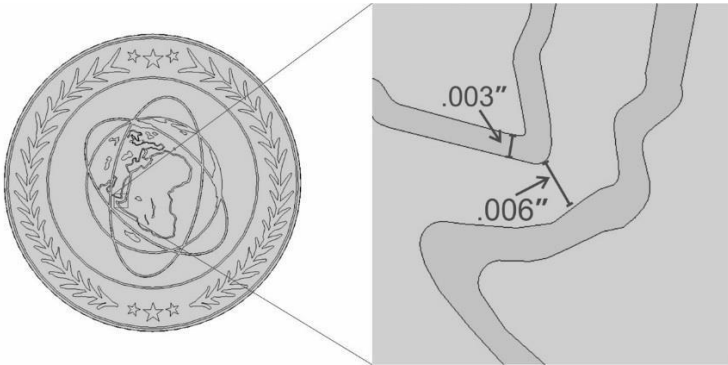

Best Practices Guide

Tactile Impression Module (TIM)

There is limited ability to reproduce fine lines, so that should be considered in your design. The minimum line thickness is .003 in (0.076mm), and .020 in (0.508mm) spacing is required between all features.

- *Minimum Line Thickness:* .003" (0.076mm)
- *Minimum Spacing:* .020" (0.508mm)
- *Minimum Spacing from ring:* .025" (0.635mm)

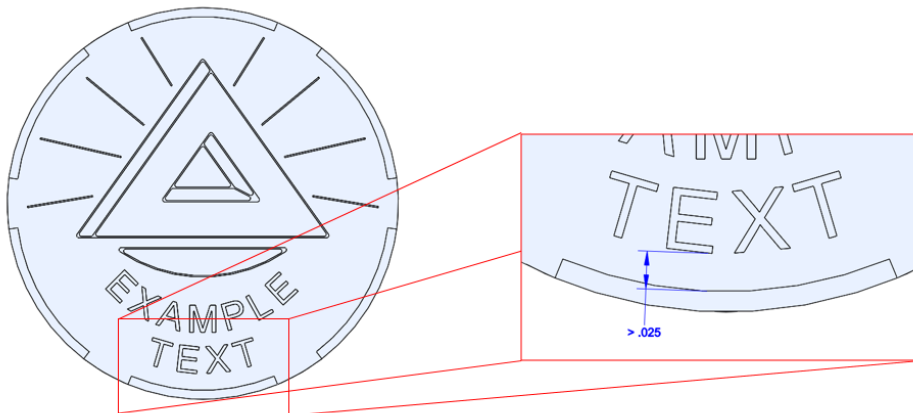
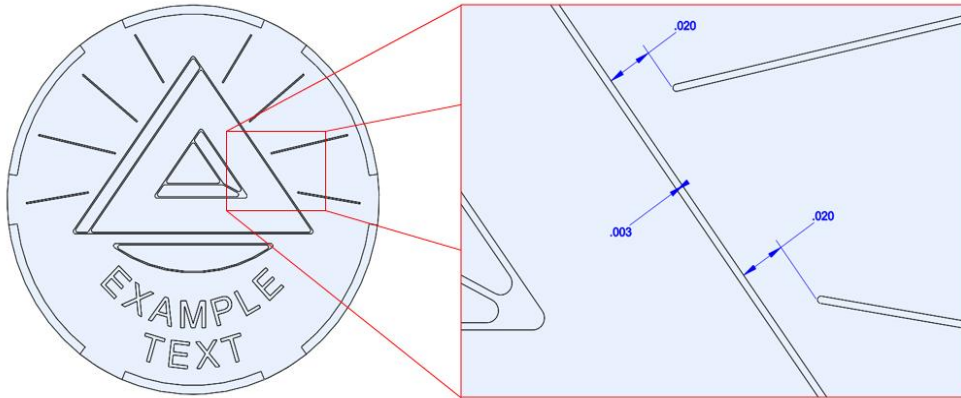

Best Practices Guide

Common Image Requirements

Sharp inside corners should be avoided, as they won't translate well onto the die. All corners should have a .005-inch (.127 mm) radius.

Example:

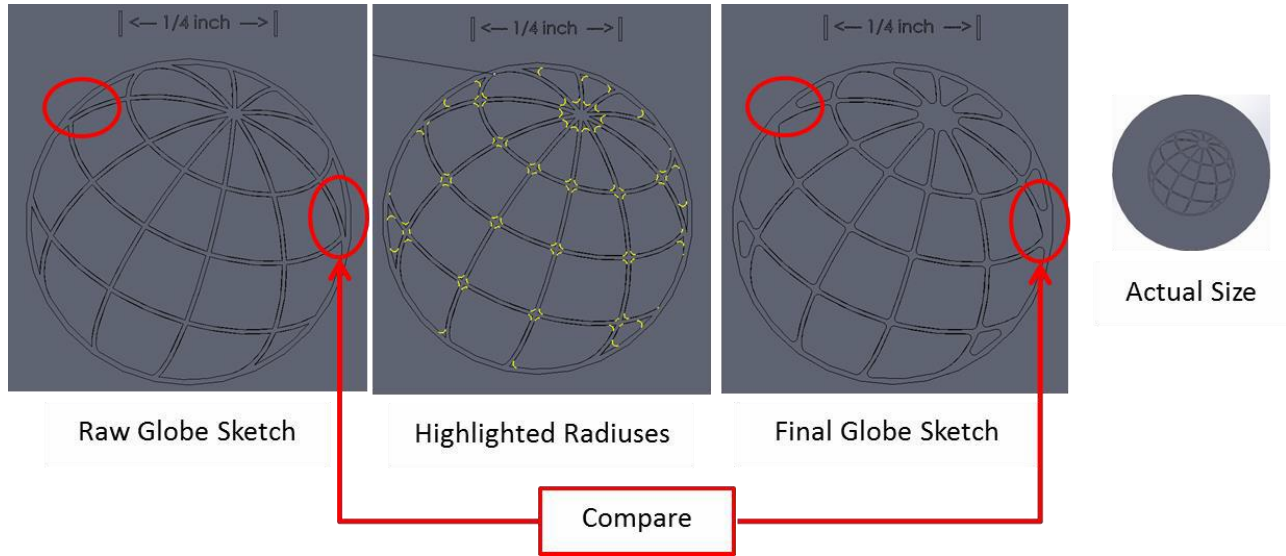

Solid areas may need to be reduced to an outline only (as shown in the elements below) in order to achieve crispness in the tactile impression. The maximum amount of protruding surface area is 0.14 sq. in (90.3 sq. mm) for a 0.86in (21.84mm) die.

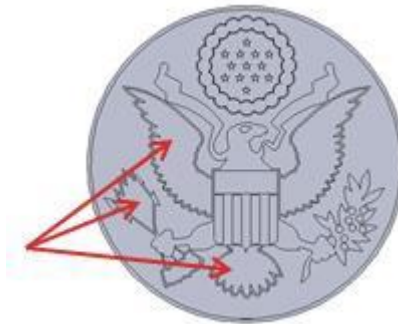

To help ensure tamper evidence and tear resistance, we recommend adding a broken circular feature to the impression as noted below.

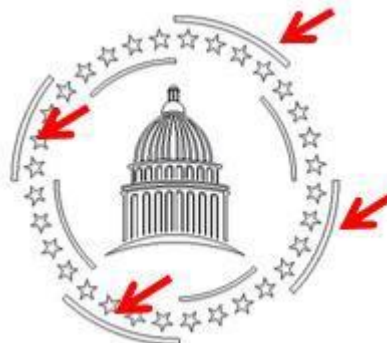

Best Practices Guide

Text Requirements

All text must meet the line thickness and spacing requirements as described above. The recommended text size is 0.06in (1.5mm) or larger, however, different fonts will have different minimum font sizes.

Using smaller than 6pt font may be less readable and may cause blurring of features.

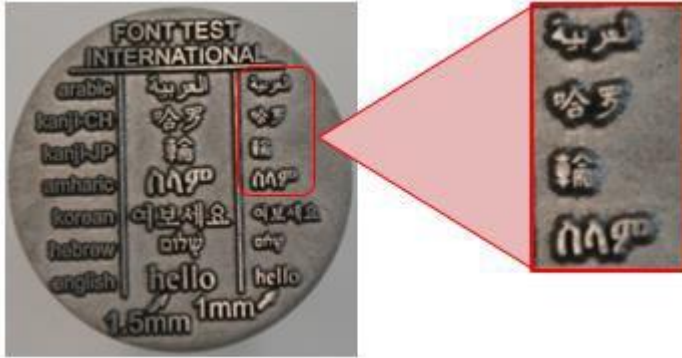

The below examples are specific to Arial font with all capitalized letters.

- Approximately 50 characters will fit in the 0.86in (21.84mm) die, depending on font and size
- Approximately 20-28 will fit in the 0.5in (12.7mm) die, depending on font and size

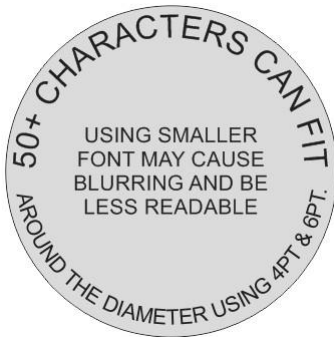

When placing text in a circle with a nearby ring the spacing between the text and the ring must be at least 0.025in.

IMPORTANT NOTE: Non-Romanized characters will need to be tested on a case-by-case basis. These still require the .006in (0.153mm) of space between all features. For example, the spaces circled in red below need to maintain this .006in (0.153mm) minimum spacing.

Design Conversion

Shading on the tactile impression is not possible, and complex designs will be simplified, if needed, when developed. Consider this when choosing an image to submit for your custom die program.

Best Practices Guide

Ordering Your Custom Tactile Impression

The process for ordering a custom tactile impression is very similar to ordering a custom holographic overlay. We have developed an order form that will allow you to provide the information we need to design the tactile impression feature. All artwork should be submitted as a vector file: .DXF (Drawing Exchange File) or Adobe Illustrator file.

The development of the artwork for approval will take approximately 5-10 business days from receipt of artwork files, depending on the complexity or the number of revisions.

Once the design is approved, delivery of the tactile impression die will take approximately 20 business days.

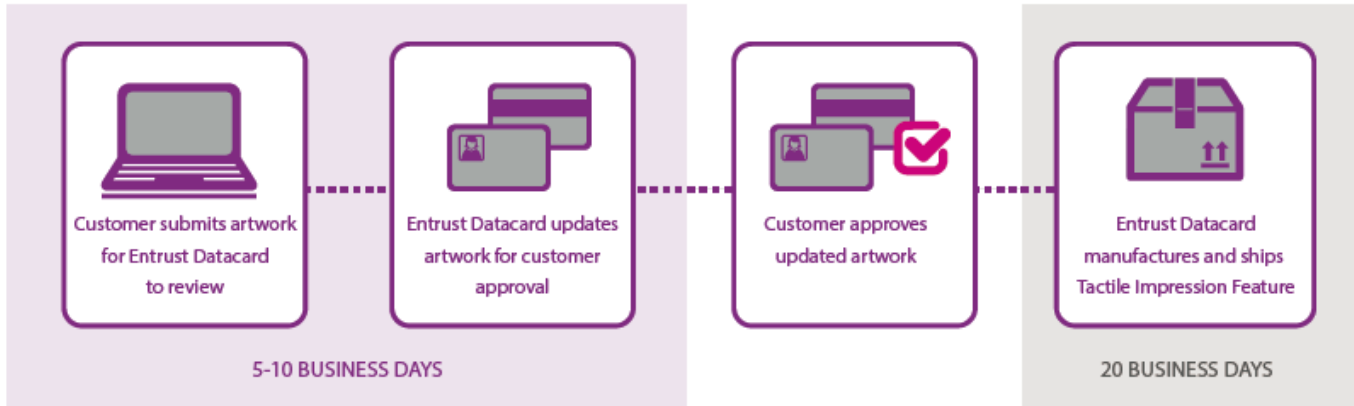

Generic Tactile Impression Feature

We have several generic designs to choose from. All of the items are stocked in our warehouse, ready for installation and shipment when you order your new card printer with lamination. Please refer to the Generic Tactile Impression Design Overview for details on our generic die offerings.

Installation of Your Tactile Impression Die

All tactile impressor modules are shipped from the factory with a default impression die installed, unless a generic or custom die is ordered with the tactile impressor module.

There are two options for receiving and installing the generic or custom tactile impression die.

Option 1: Installation at the factory. If this option is selected, the printer will ship with the tactile impressor module and the die already installed. Since generic dies are available from stock, there will be no delay to your order for selecting this service. If a custom tactile impression die is ordered, your orders will be held at the factory until the custom die is available. Additionally, at this time, factory installation is only available from the hub in Minneapolis, Minnesota, U.S.A. There is a fee for this installation.

Please refer to Price Pages for current pricing.

Option 2: Installation via an Entrust Partner. If installation by an Entrust Partner is selected, the printer will ship separately from the generic or custom die. Since generic dies are available in stock, the printer and generic die should be shipped at approximately the same time.

Custom dies have a longer lead time as noted, so there will be a lag between printer and die shipment.

Contact Information

If you have any questions, please contact your Entrust channel manager.